



Fillflex™ 5500 Compact Filling machine Installation and user manual

Model T5500C
Control system version 1.6b

FILLFLEX
– the flexible filling machines

Fillflex AB Södra Långebergsgatan 26 B, SE-421 32 Västra Frölunda, Sweden
Tel. +46-31 14 58 40 · Fax +46-31 14 58 43

info@fillflex.com
www.fillflex.se

Contents

Safety regulations

1. This is Fillflex Compact

Brief description of the Fillflex system

2. Connections and operating panel

2.1 Control shroud och operating panel

2.2 Electrical connections for external communication

3. Installation and connection of new machine

3.1 Manually started filling
(filling controlled by operator)

3.2 Mechanically started filling
(filling controlled by e.g. conveyor belt)

4. Daily operation

4.1 Quick stop

4.2 Start-up

4.3 Shut-off and cleaning

4.4 Setting of filling volume

4.5 Fine adjustment of filling volume

4.6 Adjustment of filling speed

4.7 Storing a filling programme in the memory

4.8 Using a stored filling programme

4.9 Adjusting a stored filling programme

5. Control system and its functions and programme steps

5.1 General information on control system

5.2 Control system functions on the operating panel

5.3 Sensor fault indication

5.4 Control system programme steps

5.5 Programme steps and custom settings

6. CE Certificate

***Read the
manual
carefully***



Safety regulations

All warnings are summarized below. Follow the directions carefully to avoid any injury or damage.





Installation, operating and service personnel must possess adequate knowledge of the machine.

Always begin by reading the manual.





Installation

-  Always study the technical data.
-  Only qualified electricians may open the cover of the electric equipment.
-  Never insert fingers into pump connections or any shut-off valve.

Operation

-  Always study the technical data.
-  Never touch a pump or piping containing hot liquids.
-  Never start the machine before the pump unit is properly assembled.
-  Always handle hazardous fluids with great caution.
-  Never insert fingers into pump connections or any shut-off valve.

Maintenance

-  Always study the technical data.
-  Disconnect electrical connections and any air connection before servicing.
-  Servicing must never be carried out while the pump is hot.
-  The pump and pipes must not be under pressure during servicing.
-  Never insert fingers into pump connections or any shut-off valve.

Warning symbols



General warning



Dangerous voltage



Corrosive substances

1. This is Fillflex Compact

Fillflex Compact is the latest generation of our renowned Fillflex filling machines. It is compact, versatile and economical, and its design is different to that of the traditional piston-driven filler.



Fillflex Compact is very easy to use. By simply pressing keys on a panel, the operator can conveniently increase or decrease the volume and filling speed, and equally easily store the new readings in one of the 8 pre-selector options. It is very easy to clean — the pump can even be dismantled without tools. The entire machine is made of stainless materials and is easily washed and cleaned. Since filling volumes can be altered infinitely, the same machine can be used for filling small retail-size 10 ml bottles as well as large wholesale-size

drums or vats. The containers to be filled can be fed either manually one at a time, or in a fully-automatic process for large-scale operation using conveyor belts. Fillflex Compact can also handle traditionally “difficult” media such as highly viscous foodstuffs and cleaning agents or detergents which froth easily.

Adjustment of the operating parameters on Fillflex Compact is simplicity itself. If you need to increase production, simply keep your machine and add a conveyor system and other peripheral equipment. The machine is available with a wide range of ejectors, valves and accessories for a variety of products and applications.

Products

Fillflex Compact can handle virtually all types of fluid, including highly viscous and frothing liquids.

It is used for filling jam and marmalade, marzipan, custard, sauce, paté, dressing, preservatives, yoghurt, mayonnaise, honey, washing-liquid, shampoo, degreasers, hand-cream, paint, acid, oil and other substances.

Containers

The machine can be easily adapted to suit many different types of container — everything from 10 ml bottles to dishes, jars, barrels, drums and vats. It is simplicity itself to alter or adjust the chosen filling volume. Up to 8 pre-selected options can be stored.

Power connection

230 V or 400 V. TF machine features connectors for external start-up and communication with a conveyor system etc.

Dimensions (Fillflex Compact cabinet)

Length: approx. 400 mm. Width: 260 mm. Height: approx. 400 mm.

Construction

The Fillflex system features a simple and robust design. The pump is driven by an electric motor and filler speed (rotating speed) is controlled by a separate control.

All settings for portion size, filling speed and automatic/manual operation take place via the control unit and can quickly and easily be altered by the filling operator.

Various types of installations and connections with Fillflex Split Mobile and Fillflex Compact

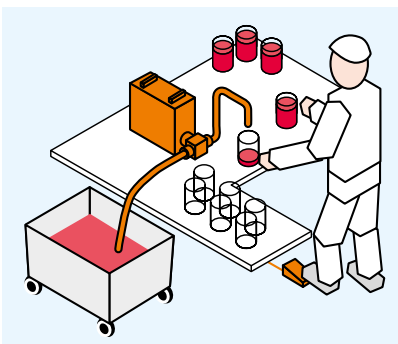

Fillflex Compact – basic version

Fillflex can be provided with different types of ejector for, for example, viscous media where there is a risk of dripping. Pedal-started.

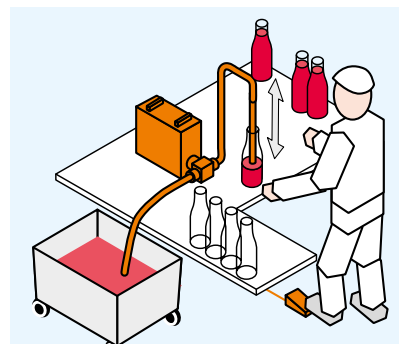

Fillflex Compact with bottom filler

Fillflex can be combined with a pneumatic bottom filler for foaming liquids etc. The bottom filler is fully controlled by the Fillflex control programme.

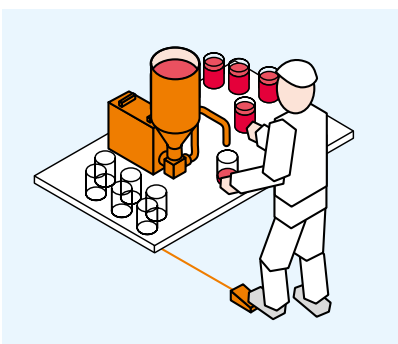

Fillflex Compact with feed hopper

Fillflex with a hopper that is filled from above and discharges at the bottom. This is a suitable arrangement for viscous media.

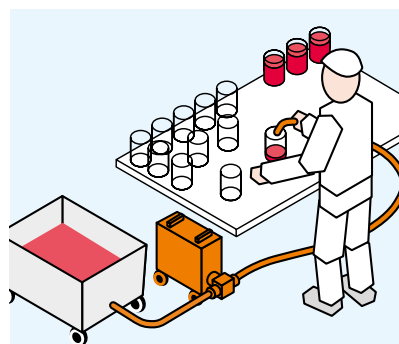

Fillflex Compact on wheels

Fillflex equipped with wheels and standing on the floor. The machine starts and stops itself and the operator need only move the ejector between the receptacles.

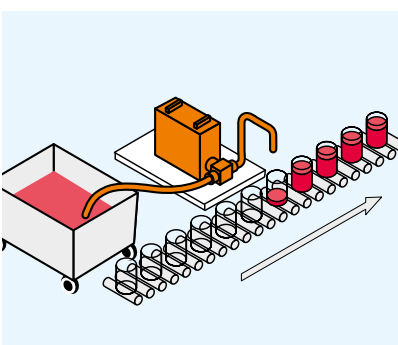

Fillflex Compact and automatic operation

The standard-version Fillflex is prepared for fully automatic operation. This makes it easy to increase output. The starting signal comes from the conveyor

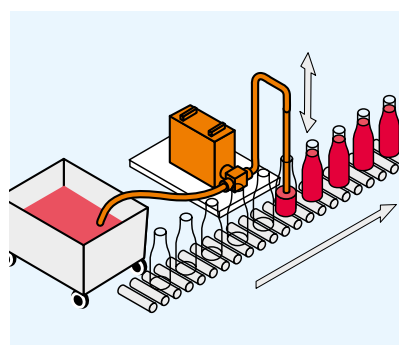

Fillflex Compact and automatic operation with bottom filler

Here automatic filling has been supplemented with a bottom filler for foaming liquids. The starting signal comes from the conveyor.

2. Connections and operating panel

2.1 Control shroud and operating panel

Fillflex Compact control shroud:

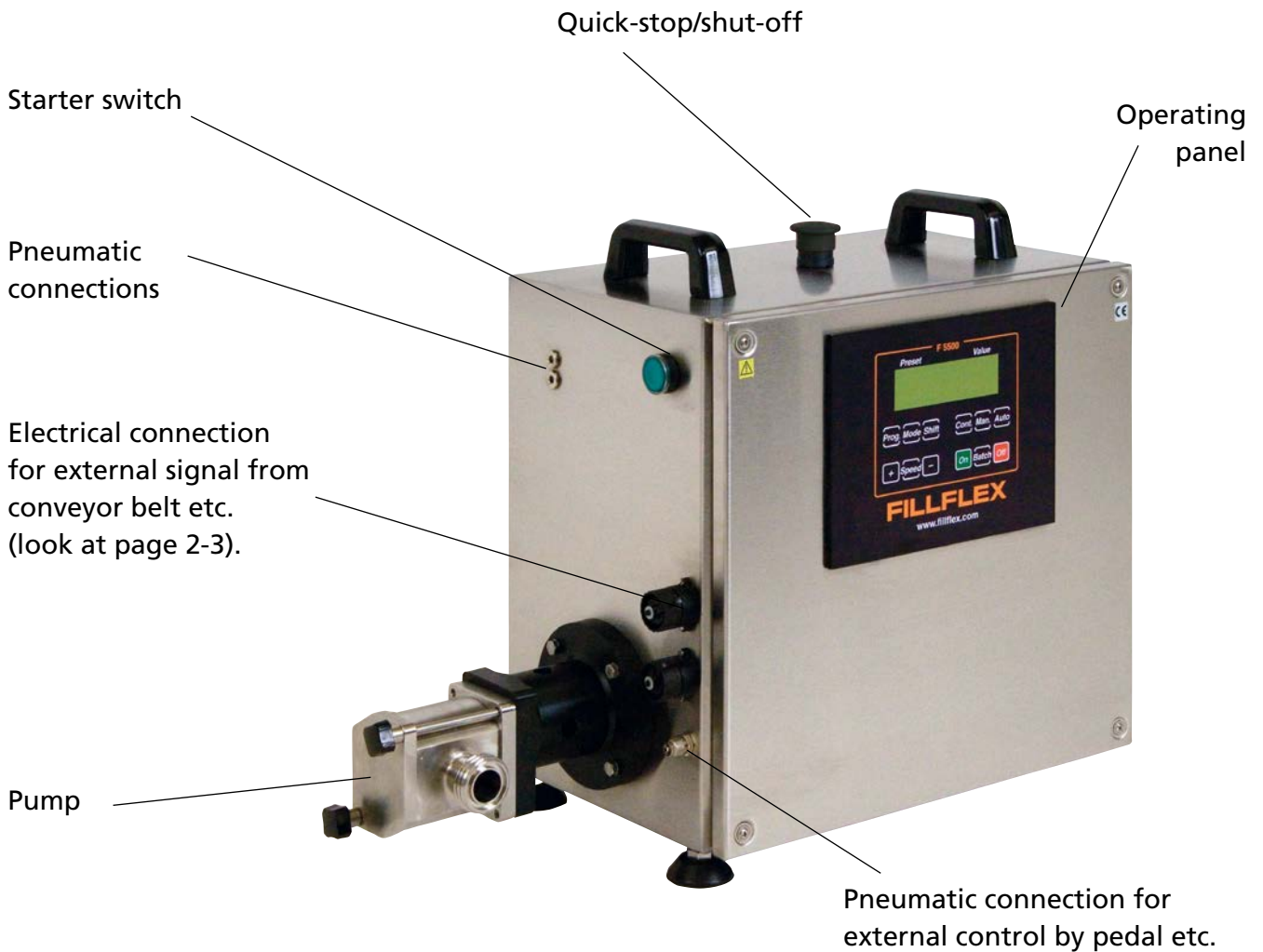

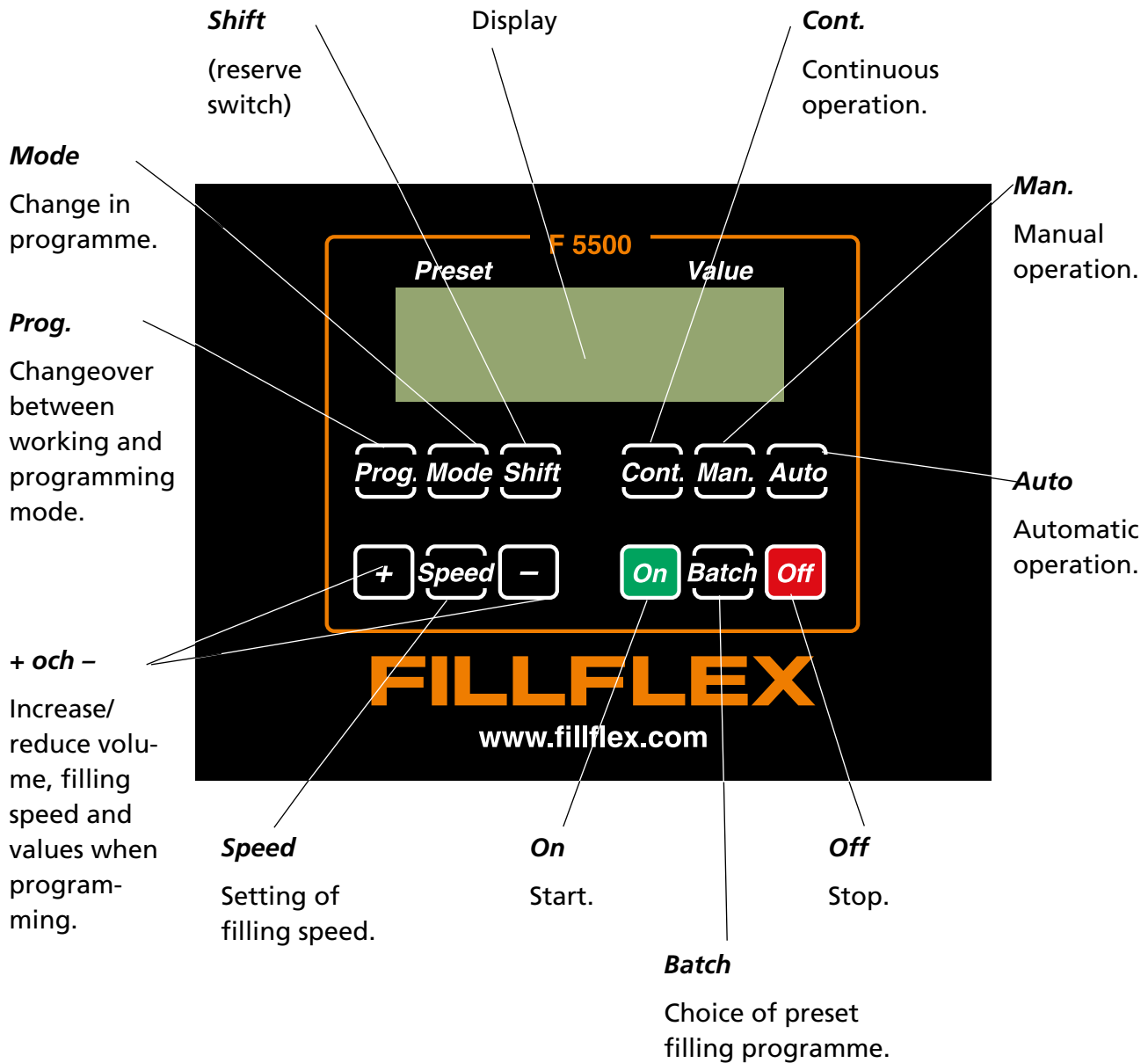

"ON" on the operating panel has the same function as external control via the electrical and pneumatic connections.

For further explanation of the operating panel functions, see 5.2 Control system functions on the operating panel.

2.2 Electrical connections for external communication

When are the X-contacts used?

X-plugs are used when external communications of different kind are to be connected with F5500T/W. X-plugs are always pre-installed inside the cabinet at delivery of a F5500T/W.

The X1-plug is used when communication for external start/stop function is connected to F5500T/W. Examples of such communication is when a conveyor is connected and used with the F5500T/W

The X2-plug is used in communication between F5500T/W and a status indicator that is attached to a valve that open inwards. This is because the pump not should work against a closed valve. An example of such communication is when our conevalve TFV20101 is used with F5500T/W.

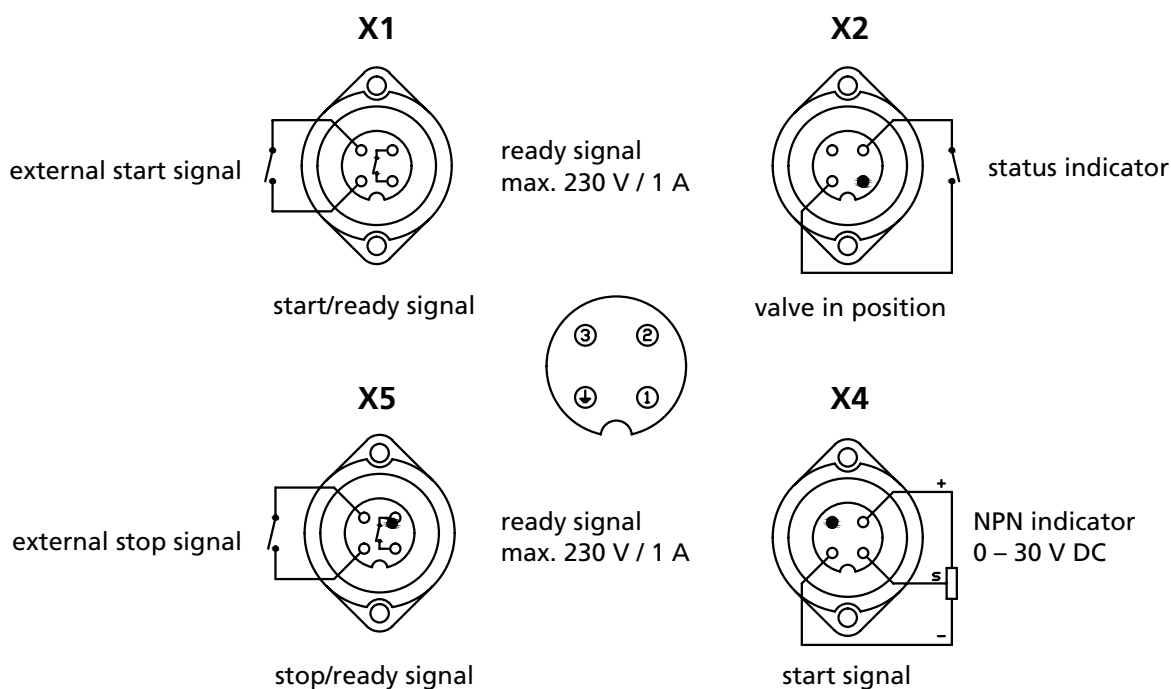

Installation of X-contacts at a F5500T/W

1. Note the color stuck into the terminals before disconnecting them.
2. Installation of X1-plug:
Disconnect X1-plug (terminals 202, 203, 204 & 206). Take the screw located on the cable and mount it on the cabinet so that the X-plug hangs outside the cabinet. Then plug the cable back to the respective terminals.
3. Installation of X2-plug:
Disconnect X2-plug (terminals 207-208). Take the screw located on the cable and mount it on the cabinet so that the X-plug hangs outside the cabinet. Then plug the cable back to the respective terminals.

N.B. When installing the X2-plug do not forget to remove the jumper inside the cabinet that sits between 207-208.

Installation of X-contacts at fixed installation of F5500T/W

1. Note the color stuck into the terminals before disconnecting them.
2. Then connect your own cable on each terminal.

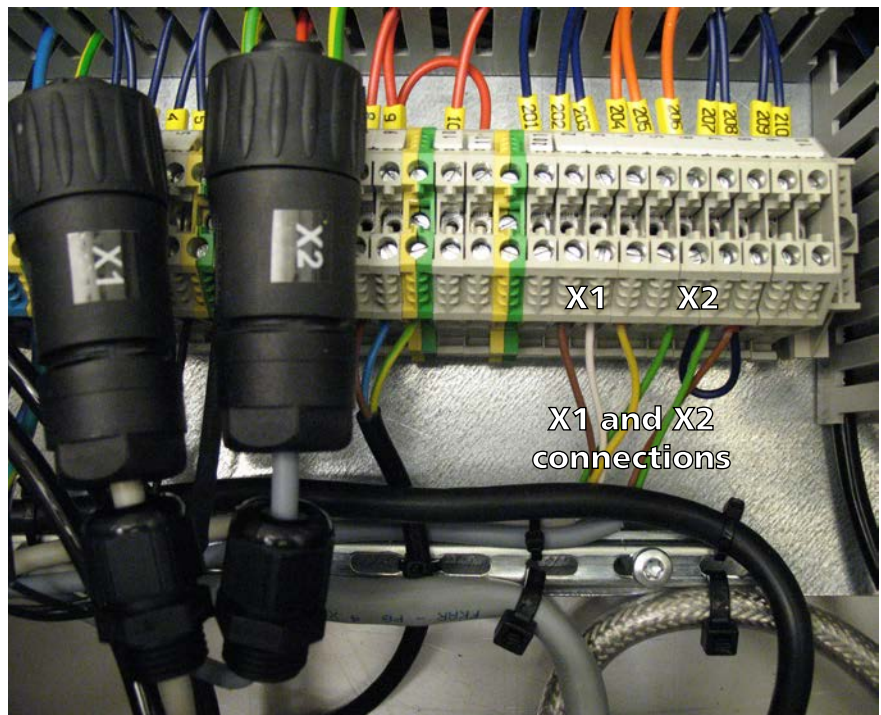

3. Installation and connection of new machine

The Fillflex Compact can be used for both:

3.1 Manually started filling (the filling process is started by an operator) or

3.2 Mechanically started filling (the filling process is started by a signal from a conveyor belt or similar equipment).

The machine may have been delivered with different types of equipment depending on its intended use (e.g. pump, different types of ejector, pneumatic valves, pneumatic pedal etc.).

Check that the equipment is complete before installation and connection.

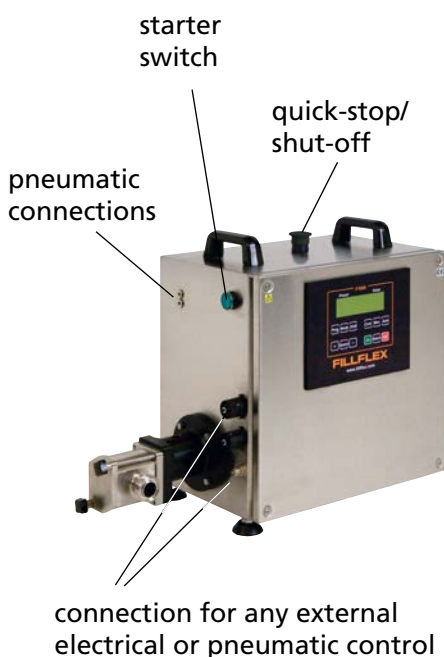

3.1 Manually started filling

The machine is delivered with a suitable pump.

The machine can always be quick-stopped with the black quick-stop button on top of the machine.

1. Mount and connect the control cabinet according to instructions inside cabinet.
2. Install the pump and connect the suction line (or filling hopper if the pump is to be equipped with one) to the inlet side of the pump.

The gear pump works equally well in both directions and has no preset direction of flow. The inlet and outlet sides can therefore be chosen as desired. Should the pump be found to "go the wrong way", the direction of flow is altered as in paragraph 7.

3. Connect the outlet (and pneumatic valve if the machine is equipped with one) to the outlet side of the pump.
4. Connect any external communication (electrical or pneumatic).
5. Turn on the power by pressing the green starter switch on the machine.

The lamp in the switch and the display on the operating panel will come on.



Display after pressing "PROG".

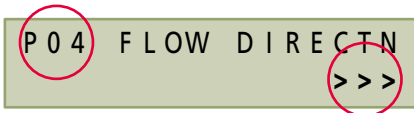

Display at P04.

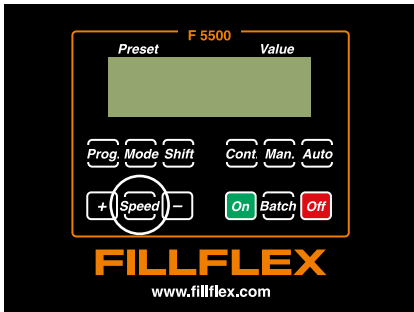

electrical connection for
external signal from conveyor
belt etc.

6. Check the direction of flow by pressing "MAN" on the operating panel. Then press "ON" briefly (the pump works as long as "ON" is kept in).

If the pump is going the wrong way, the direction of rotation is altered as follows:

- Press "OFF" on the operating panel.
- Press "PROG".
- Step forward to position P04 with "+".
- Press "MODE".
- Turn the flow arrows by pressing "+".
- Press "MODE".
- Press "PROG".

The pump will now rotate in the other direction.

7. Fill the system (pump, hose and pipe) by pressing "MAN" on the operating panel. Then press "ON". The pump will go as long as the button is pressed in.

The system must be entirely free from air before filling can begin.

8. The speed can be increased to make it easier for the pump to suck. The speed is adjusted by pressing "SPEED" and increasing/reducing with "+" or "-". Then press "SPEED" again to return the display to the operating mode.
9. The machine is now ready for setting of the filling volume (see section 4.4).

3.2 Mechanically started filling

Installation and connection take place in the same manner as with manually started filling, but with the difference that the machine receives a starting signal from the conveyor belt.

Paragraph 4 (in section 3.1) now becomes:

Connect the communication from the conveyor at the communication connection.

Connecting instructions on page 2-3 and 2-4.

4. Daily operation



4.1 Quick-stop

Fillflex Compact can always be quick-stopped with the black quick-stop button on top of the machine. Motor and pump (and the pneumatic valve on the outlet pipe, if one is fitted) will then stop immediately.

When the reason for the quick-stop has been dealt with, the machine is restarted with the green starter switch.



4.2 Start-up

For daily use the machine is started as follows:

1. Fit the pump and pneumatic valve (if applicable), if these have been removed and cleaned.
2. Connect (where applicable) the compressed air to the pneumatic valve.
3. Connect the earthed plug.
4. Press the green starter switch on the machine. The lamp in the switch and the display on the operating panel will come on.
5. Fill the system (pump, hose and pipe) by pressing "MAN" on the operating panel. Then press "ON". The pump will run as long as "ON" is pressed in.
6. When the whole system is free from air filling can begin.

X . XXX	0 . 0 0 0
P AUTO	OFF B *

The display after the starter switch has been pressed.

The last value set is shown at X.XXX.

The last chosen filling program number is shown at *.



For setting of filling volume, selection of preset programme etc, see below.



4.3 Shut-off and cleaning

The procedure for daily shutdown is as follows:

1. Flush out the system (pump, hose and pipe) with suitable rinsing agent by pressing "MAN" on the operating panel. The pump will run as long as "ON" is pressed in.

Alternatively "CONT" may be selected. The pump is then started with "ON" and shut off with "OFF" (in this case the operator can leave the machine during flushing).

2. Press the black quick-stop/shut-off button on top of the machine.

The lamp in the green starter switch and the display on the operating panel will go out and the machine is now off.

3. Remove the earthed plug. Switch off the compressed air if applicable.
4. Dismantle the pump, and pneumatic valve if fitted, for cleaning.

4.4 Setting of filling volume

When starting after shut-off the machine begins with the last chosen filling programme. Any previous setting is shown under "PRESET", e.g. "3.333".

3 . 3 3 3	3 . 3 3 3
P AUTO	OFF B *

3 . 3 3 3	0 . 0 0 0
P MAN	OFF B *

3 . 3 3 3	0 . 0 0 0
P MAN	HLT B *

3 . 3 3 3	2 . 2 2 2
P MAN	OFF B *

2 . 2 2 2	2 . 2 2 2
P MAN	OFF B *

The last chosen filling program number is shown at *.

1. Place an empty container under the ejector.
2. Press the "MAN" button. Zero "VALUE" (if it does not already show zero).
3. Press the "ON" button and keep it pressed until the desired volume is obtained (the "ON" button may be released, causing "HLT" to be shown on the display, and pressed again, the control system then continuing from the value it had when stopped).
The reading under "VALUE" begins to count up as filling proceeds.
4. Read off the current value (e.g. "2.222") under "VALUE" and set the same value under "PRESET" with the aid of the buttons "+" and "-".
5. Press "OFF", "HLT" will change to "OFF". Then press "AUTO". Next time "ON" is pressed the desired volume will be filled.

Note however:

After the first filling "VALUE" will be rather too high. The machine automatically compensates at the second filling and "VALUE" will then be the same as under "PRESET".

4.5 Fine adjustment of filling volume

If the filling volume set under "PRESET" needs fine adjustment (somewhat too little or too much in the package) this is done as follows.

1. Adjust the value under "PRESET" with "+" or "-".
2. At the next filling the adjusted volume will be filled.

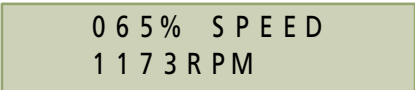

065% SPEED
1173 RPM

Ex.: Speed is 1,173 rpm, which represents 65% of maximum.

4.6 Adjustment of filling speed

1. Press "SPEED" on the operating panel.
2. Adjust the % value (speed as % of maximum) by pressing "+" or "-".
3. Press "SPEED" to return to the main menu.

The pump will now work at the new filling speed.

When adjusting the filling speed, fine adjustment of the filling volume may be necessary (see 4.5).

4.7 Store a filling programme in the memory

This is how the memory works:

- The machine can store up to eight different filling programmes in its memory. They are named B1, B2 etc up to B8 and are selected with "BATCH".
- All the adjustments which are made (e.g. change of the filling volume, speed etc.) are automatically stored in the filling programme which has been selected.
- If the machine is in the "AUTO" position it always works to one of the filling programmes B1 to B8.
- The machine always starts in the same batch programme that was used when it was shut down.
- Custom batch can be noted on pages 5-14 – 5-15.

This is how a filling programme is stored in the memory:

1. Select the desired position (B1 – B8) by pressing "BATCH". The position must always be selected before programming.
2. Make the desired settings, e.g. filling volume (see section 4.4), speed (see section 4.6) or other parameters (see section 5).
3. Do a filling.
4. The desired programme is now stored in the selected programme position.

4.8 Using a stored filling programme

1. Select the desired programme position (B1 – B8) by pressing "BATCH".
2. Press "AUTO".
3. The programme is now ready for use.

4.9 Change a stored filling programme

1. Select the programme position (B1 – B8) which it is desired to change by pressing "BATCH".
2. Make the desired adjustments.
3. Do a filling.
4. The changes are now stored in the selected programme position.

5. The control system and its functions and programme steps

5.1 General information on the control system

The Fillflex control system counts the pulses it receives from the motor and their speed. The pulses correspond to the speed (revolutions or part-revolutions) of the motor and therefore also the quantity of filling material which has passed the pump. By counting the pulses during filling and comparing them with the set values the machine can control the filling process.

There are three operating modes:

1. Continuous operation ("CONT")
2. Manual operation ("MAN")
3. Automatic operation ("AUTO")

During automatic operation the filling process can be varied according to the filling material and the container (volume, speed, cautious initial filling etc.). The adjusted filling process ("BATCH") is stored in the memory of the control unit.

1. Continuous operation ("CONT")

When on continuous operation the pump works continuously until "OFF" is pressed. This mode of operation is selected by pressing "CONT". Filling is then controlled only with "ON" and "OFF" without considering any preset stop value. This mode can be used for transport, washing, circulation or setting a large filling volume.

2. Manual operation ("MAN")

When on manual operation the pump works as long as "ON" is pressed. This mode is selected by pressing "MAN". Filling is then controlled only with "ON".

This mode is used for start-up, filling the system and setting the filling volume.

3. Automatic operation ("AUTO")

When on automatic operation the machine does a complete filling process according to the chosen settings (volume, speed, cautious initial filling etc.) after "ON" has been pressed. Then the machine stops and waits for "ON" to be pressed again. The starting impulse can also come from a hand-held switch, pneumatic pedal, automatic conveyor belt etc.

This mode is selected by pressing "AUTO" and is usually the normal operating mode for the machine.

5.2 Control system functions on the operating panel



"AUTO"

When starting, 1) the current reading is zeroed on the display under "VALUE", 2) the display shows "ON", 3) the pump starts, 4) filling begins and 5) the sensor emits pulses. The current "VALUE" counts up until it is equal to the preset value under "PRESET", after which filling stops and the display shows "OFF".

The machine can be stopped in the middle of a filling process with the "OFF" button. The display then shows "HLT". When the start button "ON" is pressed the control system continues from the value reached when the machine was stopped.

To begin from 0 with a new filling after a manual stop press the "AUTO" button.

"MAN"

Filling is manual and the pump only works as long as the start button "ON" (or pedal or similar) is pressed in.

The current "VALUE" is not zeroed if the start button "ON" is pressed.

It is zeroed by first pressing the "OFF" button and then the "MAN" button.

This mode of operation is used for start-up, filling the system and setting the filling quantity.

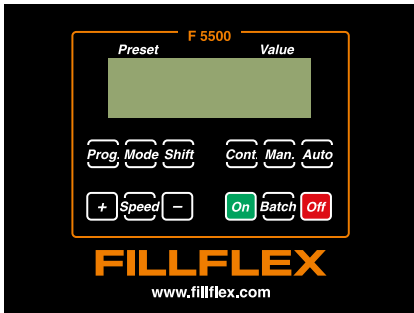

“CONT”

The machine is operated only with the start and stop buttons “ON” and “OFF” without taking into account any preset stop value. This mode of operation can for example be used for transport, washing, circulation or setting a high filling quantity.

“VALUE”

Current (real) value. Shows the number of pulses from the last zero-setting.

“PRESET”

Preset (desired) value. Shows the value at which stop occurs when running on “AUTO”.

“+”

Setting of value on display under “PRESET”.

A single quick press raises the value in steps, if “+” is kept pressed, the value rises continuously at a constant speed, which increases after 3 seconds.

“-”

Setting of value in display under “PRESET”.

A single quick press lowers the value in steps, if “-” is kept pressed, the value falls continuously at a constant speed, which increases after 3 seconds.

“ON”

Start of filling process during continuous, manual or automatic operation.

“OFF”

Stopping of filling process during continuous operation.

During manual operation filling is stopped by releasing “ON”, on automatic it is stopped by the control unit.

“BATCH”

With “BATCH” one of the stored programmes (up to eight in number) is selected.

The machine always starts in the same batch programme that was used when it was shut down.

Repeated pressing of the "BATCH" button moves the display up to B8 and then begins again with B1.

"SPEED"

```
0 6 5%  S P E E D  
1 1 7 3 R P M
```

Alternate between operating mode and speed mode.

The display shows the word "SPEED" and the pump speed in revolutions per minute, "RPM".

The filling speed can be increased and reduced steplessly with the buttons "+" and "-".

"PROG"

Alternate between operating and programming mode.

To go up and down the programme steps the buttons "+" and "-" are used.

When the machine has been dead step P01 is always shown in the programming mode.

```
P 0 5  A U T O  S T A R T  
N E X T  F I L L      N O
```

If for example programme step P05 is shown when returning to the operating mode, P05 will come up at the next change from operating to programming mode.

"MODE"

Change to alteration of the programme step which is displayed. An arrow is shown before the value or the text which may be altered.

To increase or reduce the value (or alternate between two or more fixed choices, e.g. YES/NO) the buttons "+" and "-" are used.

"SHIFT"

Spare button

!! SENSOR FAULT !!

5.3 Sensor fault indication

If "YES" has been selected at programme step P34, the control programme will alarm and switch off the machine if the signal from the sensor is incorrect.

An incorrect signal is when the time between two motor revolution pulses (set on programme step P03) is longer than the time (+ an extra second) which has been set at P03. In addition filling should be in progress.

The pump does not rotate. Possible causes/ action:

The pump is blocked — remove the blockage.

Speed set too low — increase the filling speed (see 4.6).

The frequency control has tripped — shut off the machine and restart.

The pump rotates, but "VALUE" does not change on the display. Action:

Contact your machine supplier or Fillflex AB.

5.4 All the steps in the control programme

The programming mode is obtained as follows:

1. Press "PROG" on the operating panel.
2. Step forward to the desired programme step with "+".
Note that inapplicable programme steps are omitted. For example P06 and P07 are not shown unless "YES" has been selected under P05.
3. Press "MODE". The step is now adjustable.
4. Make the changes "+" and "-".
5. Leave the step by pressing "MODE".
6. Select a new programme step or leave the programming mode by pressing "PROG".
7. Custom Settings on the panel could be noted in in table at page 5-14 – 5-15

P 0 1 P U L S E / R E V

0 1

P01 Number of pulses per revolution of motor

Function: Value for number of pulses per revolution of the motor. To see the speed of the motor in rpm.

Possible values: 1 – 99.

P 0 2 P U L S E R A T I O
O U T 1 = I N P U T 0 0 1

P02 Number of pulses received before the control programme counts a control pulse.

Function: The number of pulses received from the motor per control pulse counted in the control programme. Used to reduce large numbers of pulses so that the working range of the machine will be adequate.

Possible values: 1 – 255.

Example: If the value 255 is selected, the control programme will count 1 control pulse only after 255 motor revolution pulses have been counted.

P03 STOP DETECT
PULS - PULS 1.00 s

P03 Time between two motor revolution pulses before stop is confirmed

Function: To enable the control programme to know if the pump has stopped or is about to stop.

Possible values: 0.01 – 9.99 s (seconds).

Example: If the time is long (e.g. 1.00 s), the motor has stopped. If the time is short (e.g. 0.10 s) the motor has not stopped completely. If 8 pulses/rev. (see P01) has been selected and 0.10 between two pulses has been selected, the stop indication will come at 75 rpm (60 divided by [stop time between two pulses x pulses/rev.]

P04 FLOW DIRECTN
>>>

P04 Changing direction of flow

Funktion: Function: Change of direction of flow (direction of rotation of motor).

Possible values: <<< or >>>

P05 AUTO START
NEXT FILL NO

P05 Automatic start after change of packing

(P05 is used with P06 and P07)

Function: Automatic start after the time which is set on P07.

Used, for example, to enable a large number of packages to be filled more quickly. The operator then has the time set under P07 to change the package. Filling then starts automatically without a new start signal needing to be given.

Possible values: YES or NO.

P06 EXTERN START
CONT

P06 Selection of start and stop method with automatic start

(P06 is used if "YES" has been chosen on P05)

Function: Choice of starting and stopping method with automatic starting.

Possible values: "CONT" or "IMP"

"CONT": As long as an external sensor (e.g. pedal) is active (depressed) a new start signal will come automatically after the time set on P07. When the external sensor becomes inactive (pedal released), the filling which has started will be completed, after which automatic filling stops until the external sensor is activated again.

The display shows "ON" all the time until the signal for automatic start stops (the pedal is released).

"IMP": A short pulse (one push on the pedal) from an external sensor starts the automatic start function with the pause time set on P07. When the external sensor is activated again (new pressure on the pedal), the filling which has been started will be completed, after which the automatic filling stops, until the external sensor is activated again.

The display shows "ON" all the time after the first external start impulse is given, until the next external signal for automatic start comes. The display then shows "OFF".

P07 PAUSE TIME
NEXT FILL 5.00 s

P07 Setting of pause time from stop to new start of next filling

(P07 is used if "YES" has been chosen at P05)

Function: Used to select the time the operator needs to change packing.

Possible values: 0.01 – 9.99 s (seconds)

P08 REVERSING
NO

P08 Reversing of direction of flow at end of filling process

P08 is used with P09 and P10)

Function: Reversing of direction of flow of gear and lobe pumps to reduce the dripping tendency when filling with viscous products. The filling process is completed when the pump runs in the opposite direction (with the number of pulses given at P08) after which the product remaining outside the filling nozzle is withdrawn slightly.

If a hose is used for filling and reversing is not used, the product will come out through the filling nozzle when the pump stops and the hose returns to its original diameter.

Possible values: YES or NO

P 0 9 REVERSING
PULSES 0 0 0

P09 Number of pulses for which pump reverses at P08

(P09 is used if "YES" has been selected at P08)

Function: The number of pulses which the pump runs in the reverse direction, reversing begins when stop is detected at P03. The number of pulses for which the pump is run in the opposite direction of flow has to be repeated by the pump in the forward direction at the next filling before the volume begins to count.

Possible values: 0 – 999

P 1 0 REVERSING
SPEED 0 2 0 %

P10 Speed of reversing at P08

(P10 is used if "YES" has been chosen at P08)

Function: The speed with which reversing proceeds as % of maximum speed.

Possible values: 0 – 100%.

P 1 1 COMPENSATION
PRESET/VALUE YES

P11 Compensation for difference in "PRESET" and "VALUE"

Function: When doing the first filling after shut-off the pump stops when "PRESET" and "VALUE" are the same, which means that the pump rotates after one or more additional pulses depending on the speed.

The values "PRESET" and "VALUE" must be the same all the time. By selecting "YES" at P11 continuous compensation is obtained for differences between "PRESET" and "VALUE", both upwards and downwards. "PRESET" and "VALUE" then remain the same all the time.

Possible values: YES or NO.

"YES": If YES is selected the stop signal in the next filling will come as many pulses earlier as the excess number in the preceding filling.

"NO": If NO is selected, the stop signal will come when "PRESET" and "VALUE" are equal.

P 1 2 PULSE MULTI
FACTOR 1.000

P12 Constant between pulses and volume

Function: Constant by which the number of pulses is multiplied to enable the value of "PRESET" and "VALUE" to agree with the numerical value for volume or weight in the package which is being filled.

Possible values: 0.001 – 9.999

Example: If a filled volume of 650 ml gives a numerical value of 400 pulses, the factor will be $650/400 = 1.625$. By setting the constant 1.625 under P12 the numerical value on the display will show the number of ml.

The value obtained is then combined with the units in P13.

P 1 3 CHOICE OF
UNITS P

P13 Choice of units

Function: To give the right unit for the value after setting in P12.

Possible values: P (pulses), l (litres), dl, cl, ml, kg, hg and g.

Example (compare P12): If "ml" is selected, the display will show "650 ml".

P 1 4 PUMP START
DELAY 0.00 s

P14 Delay of pump start

Function: Used if the filling machine is equipped with a pneumatically controlled outlet valve. Delay of pump start is used when the shut-off valve is connected in order to be able to give the valve time to open before the pump starts. In this way there is no build-up of pressure before the valve opens (if the valve opens with pressure in the pipe, there may be splashing).

Possible values: 0.00 – 9.99 s (seconds).

P 1 5 VALVE CLOSE
DELAY 0.00 s

P15 Delay of valve closure after filling

Function: Used if the filling machine is equipped with a pneumatically controlled outlet valve. Delay of valve closing after filling, to avoid the pressure in the pump system remaining in the pipe after stopping (if there is pressure in the pipeline at the next filling, there may be splashing).

Possible values: 0.00 – 9.99 s (seconds).

P 1 6 VALVE CLOSE
AFTER STOP YES

P16 Synchronization of valve closure and pump stop

Function: Used if the filling machine is equipped with a pneumatically operated outlet valve. To obtain the optimum setting between valve closure and pump stop.

As the pump does not stop immediately (because of the speed of rotation) when the control system signals stop, filling continues for a short time. To prevent dripping it is possible to select to shut the pneumatic valve at the same time as the pump stops or after the pump stops.

If "NO" is selected, the valve closes and the pump stops at the same time.

If "YES" is selected, the valve closes after the pump has stopped. The time between the pump stopping and the valve closing can be determined by a setting (or two settings):

- 1) The time which has been selected under P03 (the time after which the control programme will by definition think that the pump has stopped). At this point the valve is closed if P15 is 0.
- 2) If in addition a delay time has been set under P15, this time is added to the time under P03. For example, if 0.5 sec. has been selected under P03 and 1.2 sec has been selected under P15, the valve closes 1.7 sec. after the pump has received its stop signal.

Possible values: NO or YES.

P 1 7 SPEED UNIT
RPM

P17 Selection of unit to be shown in "SPEED" position

Function: Selection of desired unit to be shown in "SPEED" position.

Possible values: RPM, %, l/m (litres per minute) or similar according to the unit chosen at P13.

P 1 8 BATCH COMP.
NO

P18 – P22 Automatic compensation for external factors

Programme steps P18 – P22 are intended for compensation and setting of compensation.

For more information, contact Fillflex AB.

P 2 3 P R E - F I L L I N G
N O

P23 Slow prefilling at start of filling

(P23 is used together with P24 and P25)

Function: Used to avoid foaming and splashing and to increase the total filling speed.

Possible values: NO or YES.

P 2 4 P R E - F I L L I N G
S P E E D 0 2 0 %

P24 Speed for slow prefilling at start of filling

(P24 is used if "YES" has been selected at P23)

Function: Used to give the speed of the amount of prefilling set at P25.

Possible values: 0-100% (of max. speed).

P 2 5 P R E - F I L L I N G
A M O U N T 0 2 0 %

P25 Proportion of slow prefilling at start of filling

(P25 is used if "YES" has been selected at P23)

Function: Used to indicate the proportion of the total filling which is to proceed more slowly. After this amount has been filled, the speed changes to the basic speed set in the "SPEED" mode.

Possible values: 0 – 100% (% of filling amount)

P 2 6 E N D F I L L I N G
N O

P26 Slow top filling at end of filling process

(P26 is used together with P27 and P28)

Function: Top filling (end filling) to reduce filling speed at the end of filling.

Used to give the product time to run out into the whole package (any foam must have time to settle in whole or part) or to reduce the speed when filling packages which narrow at the top.

The function is also used to reduce the effect of differences in stop and shut-off times.

Possible values: NO or YES

P 2 7 E N D F I L L I N G
S P E E D 0 2 0 %

P27 Speed of slow top filling at end of filling process

(P27 is used if "YES" has been selected at P26)

Function: Used to give the speed after the quantity of total filling set at P28.

Possible values: 0 - 100% (of max. speed)

P 2 8 E N D F I L L I N G
S T A R T 0 8 0 %

P28 Proportion of slow top filling at end of filling process

(P28 is used if "YES" has been selected at P26.)

Function: Used to specify the proportion of total filling after which the slower end filling is to start. When this quantity has been filled, the speed changes from the basic speed (set in the "SPEED" mode) to the end filling speed set at P27.

Possible values: 0 – 100% (of total filling amount)

P 2 9 F I L L I N G F R O M
B O T T O M N O

P29 Bottom filling with filling lance

(P29 is used together with P30)

Function: Used if the filling machine is equipped with pneumatically controlled filling lance. The speeds for movement up and down are set with separate throttle valves on the pneumatic cylinder.

Used for filling foaming products or to avoid splashing.

Possible values: NO, FINISHED or TIME

"FINISHED": At the start signal for filling the filling lance goes down to its bottom position. When the control unit receives the signal that the lance is in position, filling starts and the filling lance remains in the bottom position until filling is complete. Then the filling lance is drawn up again quickly.

"TIME": As above, but the filling lance remains in the bottom position only for the time set at P30, after which it slowly rises to allow the liquid to flow out under the surface. When filling is complete the filling lance rises quickly for the remaining distance.

P 3 0 TIME IN
BOTTOM POS 0 0 . 0 s

P30 Time for filling lance in bottom position

(P30 is used if "TIME" has been selected at P29)

Function: Determines the time that the filling lance stays in the bottom position before being slowly raised.

Possible values: 0.00 – 9.99 s (sec).

P 3 1 SYSTEM READY
SIGNAL YES

P31 Ready signal via auto/ready signal relay

(P31 is used together with P32)

Function: Gives ready signal via auto/ready signal relay. Usually used for filling on conveyor belt.

Possible values: YES or NO

P 3 2 READY SIGNAL
TIME DELAY 0 . 0 0 s

P32 Delay of ready signal via auto/ready signal relay

(P32 is used if "YES" has been selected at P31)

Function: Used to delay ready signal, for example to wait for other equipment or to avoid dripping in wrong place.

Possible values: 0.00 – 9.99 s (seconds)

P 3 3 RESTART FROM
ZERO NO

P33 Restart from zero

Function: Used for restart from zero at next start if external stop signal has stopped filling before the set volume has been reached.

Possible values: YES or NO.

P 3 4 CONNECT
SENSOR FAULT YES

P34 Connection and disconnection of sensor fault indication

Funktion: Function: Connects or disconnects indication of sensor fault

"YES": Indicates and shuts off the machine in case of fault.

"NO": Function disconnected. This position is normally used only for running- in and special operation, which is usually carried out by specialist personnel.

See also "5.3 Sensor fault indication".

Possible values: YES or NO

```
P 3 5   B C   5 5 0 0  
      V E R S I O N   1 . 6
```

P35 Type and version of control unit

Notes

Batch 1

Value:

Speed:

Batch 2

Value:

Speed:

Batch 3

Value:

Speed:

Batch 4

Value:

Speed:

Batch 5

Value:

Speed:

Batch 6

Value:

Speed:

Batch 7

Value:

Speed:

Batch 8

Value:

Speed:

Programme steps and custom settings

Program- steg	Display	Default i rött	Batch B1	Batch B2	Batch B3	Batch B4	Batch B5	Batch B6	Batch B7	Batch B8
1	Pulse	48								
2	Pulse Ratio	Out 1 = Input 001								
3	Stop Detect	0,10s								
4	Flow Direction	>>>								
5	Autostart Next fill	No / Yes*								
6	Extern start	Count / Imp								
7	Paus time next fill	5,00s								
8	Reversing	No / Yes*								
9	Reversing pulses	0000								
10	Revering speed	020%								
11	Compen- sation Present/ Value	Yes / No*								
12	Pulse Multi Factor	1,000								
13	Choice of Units	P								
14	Pump Start Delay	0,00 s								
15	Value Close Delay	0,00 s								
16	Value Of Close Af- ter Stop	Yes								
17	Speed Unit	RPM								
18	Batch Comp	No**								
19	Adjust- ment of pulses	001**								
20	Batch max adjust- ment	+0,00**								

Program- steg	Display	Default i rött	Batch B1	Batch B2	Batch B3	Batch B4	Batch B5	Batch B6	Batch B7	Batch B8
21	Quantity delay comp	000**								
22	Ext. Input Adj.To Zero	No**								
23	Pre Filling	No / Yes*								
24	Pre Filling speed	020%								
25	Pre Filling amount	020%								
26	End Filling	No / Yes*								
27	End Filling speed	020%								
28	End Filling start	080%								
29	Filling From Bottom	No / Yes*								
30	Time in bottom pos	1,00s								
31	System Ready Signal	Yes								
32	Ready Signal Time Delay	0,0 s								
33	Restart From Zero	No / Yes*								
34	Connect Sensor Fault	Yes / No*								
35	BC 5500 Version	1,6								

* If you change this program step, different program steps could appear afterwards. If you feel uncertain, read the manual before you change

** Fore more information, contact Fillflex AB

EC DECLARATION OF CONFORMITY OF THE MACHINE

We, the undersigned,

Manufacture: FILLFLEX AB
Adress: Södra Långebergsgatan 26B
Country: Sweden

Contact:

T: +46 31 14 58 40

F: +46 31-14 58 43

E-post: info@fillflex.com

Declares under its sole responsibility that the product:
Fillflex filling machine,

Type:

Serial nr:

To which this Declaration is in conformity with the following standards or other regulatory documents and meet that all applicable provisions under the terms of Directive:

2006/42/EC,

and

EMC Directive 2004/108/EC (2007)

LVD Directive 2006/95/EC (2007)

Göteborg 2014-06-25

Pär Nygren



FILLFLEX